

This guide provides basic information for Unitronics' Models V230/280/290 (Non-color Screens).

General Description

Vision PLC+HMIs are programmable logic controllers that comprise an integral operating panel containing a graphic LCD screen and a keyboard. All models offer the same PLC features. Operating panel features differ according to model.



V230
LCD + Keyboard



V280
Touchscreen +
Keyboard



V290
Touchscreen only

Communications

- 2 serial ports: RS232 (COM1), RS232/RS485 (COM2)
- 1 CANbus port
- The user can order and install an additional port. Available port types are: RS232/RS485, and Ethernet
- Communication Function Blocks include: SMS, GPRS, MODBUS serial/IP Protocol FB enables PLC to communicate with almost any external device, via serial or Ethernet communications

I/O Options

Vision supports digital, high-speed, analog, weight and temperature measurement I/Os via:

- Snap-in I/O Modules
Plug into the back of the controller to provide an on-board I/O configuration
- I/O Expansion Modules
Local or remote I/Os may be added via expansion port or CANbus

Information Mode

This mode enables you to:

- View & Edit operand values, COM port settings, RTC and screen contrast/brightness settings
- Calibrate the touchscreen
- Stop, initialize, and reset the PLC

To enter Information Mode, press the <i> button for several seconds.

Programming Software, & Utilities

- VisiLogic
Easily configure hardware and write both HMI and Ladder control applications; the Function Block library simplifies complex tasks such as PID. Write your application, and then download it to the controller via the programming cable included in the kit.
Note that in order to program the V290-19-B20B, you must select the V280/V530 in VisiLogic's Hardware Configuration.

- Utilities
These include UniOPC server, Remote Access for remote programming and diagnostics, and DataXport for run-time data logging

To learn how to use and program the controller, as well as use utilities such as Remote Access, refer to the VisiLogic Help system.

Operand Types Memory Bits 4096 | Memory Integers, 16-bit, 2048 | Long Integers, 32-bit, 256 | Double Word, 32-bit unsigned, 64 | Memory Floats, 32-bit, 24 | Timers, 32-bit, 192 | Counters, 16-bit, 24



Additional product documentation is in the Technical Library, located at www.unitronicsplc.com. Technical support is available at the site, and from support@unitronics.com.

Kit Contents

Vision controller	Grounding hardware
Mounting brackets (x4)	Rubber seal
3 pin power supply connector	Extra set of keyboard slides, according to model
5 pin CANbus connector	
CANbus network termination resistor	

Alert Symbols and General Restrictions

When any of the following symbols appear, read the associated information carefully.



Symbol	Meaning	Description
	Danger	The identified danger causes physical and property damage.
	Warning	The identified danger could cause physical and property damage.
<i>Caution</i>	Caution	Use caution.

- Before using this product, the user must read and understand this document
- All examples and diagrams are intended to aid understanding, and do not guarantee operation. Unitronics accepts no responsibility for actual use of this product based on these examples
- Please dispose of this product according to local and national standards and regulations
- Only qualified service personnel should open this device or carry out repairs

 Failure to comply with appropriate safety guidelines can cause severe injury or property damage

- Do not attempt to use this device with parameters that exceed permissible levels
- To avoid damaging the system, do not connect/disconnect the device when power is on

Environmental Considerations

-  Do not install in areas with: excessive or conductive dust, corrosive or flammable gas, moisture or rain, excessive heat, regular impact shocks or excessive vibration, in accordance with the standards given in the product's technical specification sheet
- Ventilation: 10mm space required between controller's top/bottom edges & enclosure walls
-  Do not place in water or let water leak onto the unit
- Do not allow debris to fall inside the unit during installation
- Install at maximum distance from high-voltage cables and power equipment

Mounting

Dimensions

V230

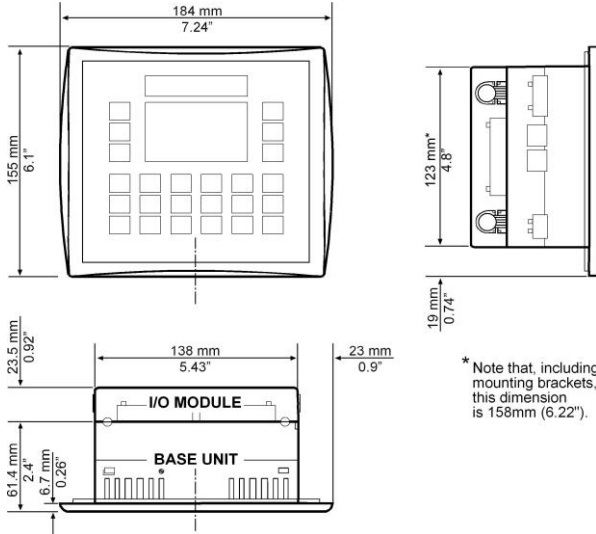

* Note that, including mounting brackets, this dimension is 158mm (6.22").

V280

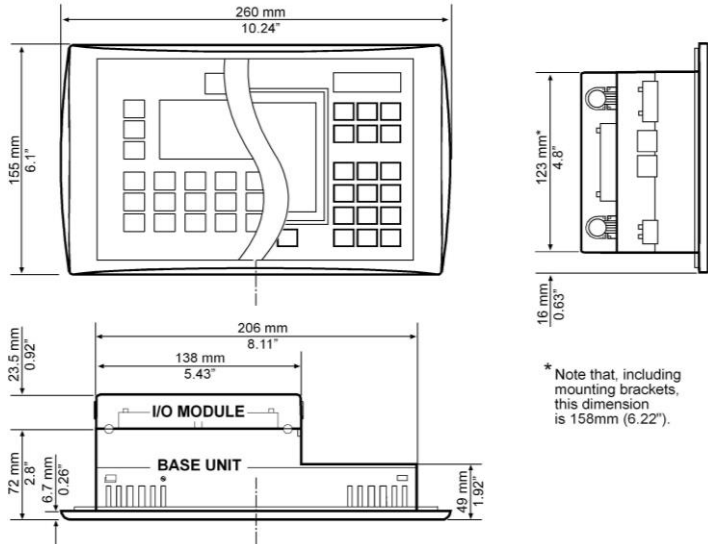

* Note that, including mounting brackets, this dimension is 158mm (6.22").

V290

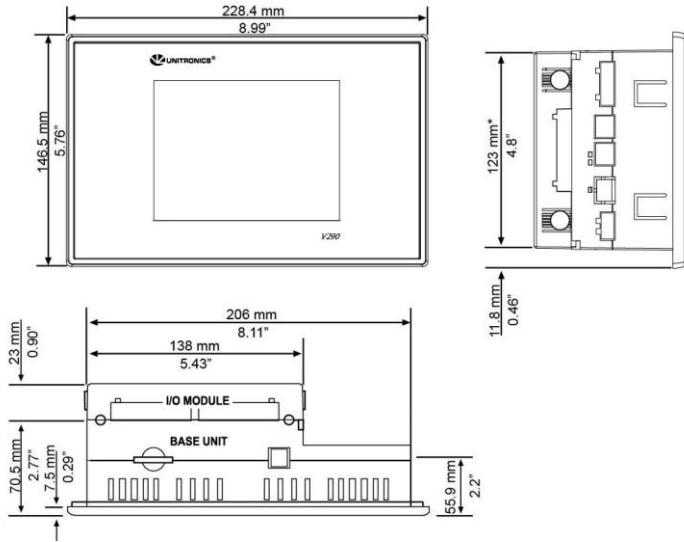

Mounting

Before you begin, note that:

- The mounting panel cannot be more than 5 mm thick
- To minimize electromagnetic interference, mount the controller on a metal panel and earth the power supply according to the details on page 6.

1. Make a panel cut-out that suits your model controller.

V230 Cut-out Dimensions

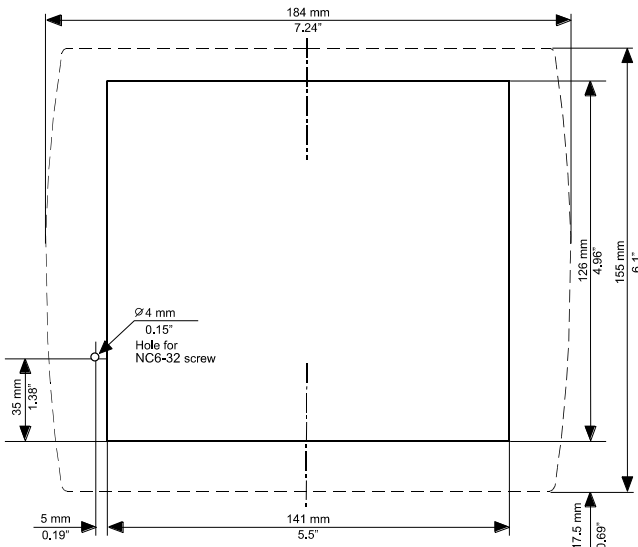

V280 Cut-out Dimensions

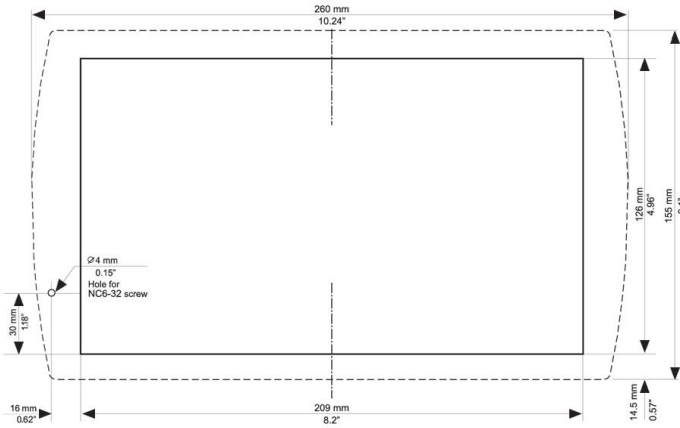

V290 Cut-out Dimensions

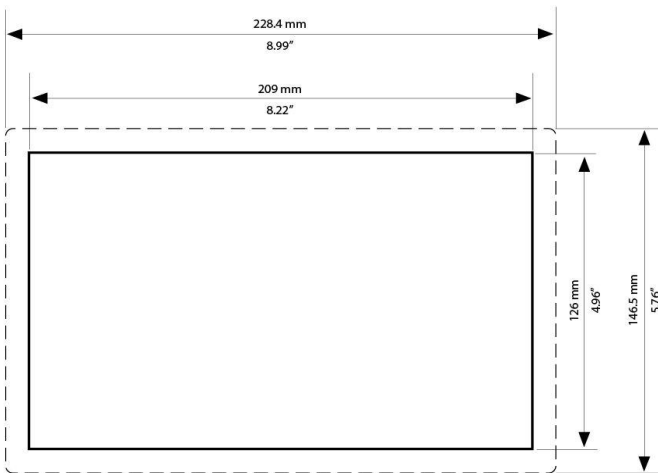

2. If you mount the controller on a metal panel, earth the power supply **only in V230**:

- a. Bore a hole to suit the NC6-32 screw supplied with the kit.
- b. Scrape panel paint away from the contact area to ensure a conductive connection.
- c. Drive the screw into the hole.
- d. Place the following hardware screw's shank, in the order shown in the accompanying figure: washer, ring cable shoe, second washer, spring, and nut.

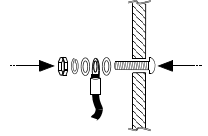

- **Pay Attention:**
The wire used to earth the power supply must not exceed 10 cm in length if your conditions do not permit this, do not earth the power supply.
- Make sure that the metal panel is properly earthed.

3. Slide the controller into the cut-out, ensuring that the rubber seal is in place.

4. Push the 4 mounting brackets into their slots on the sides of the controller as shown in the figure to the right.

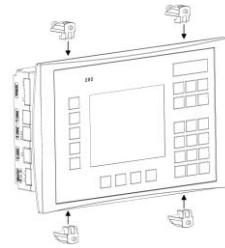

5. Tighten the bracket screws against the panel. Hold the bracket securely against the unit while tightening the screw.

6. When properly mounted, the controller is squarely situated in the panel cut-out as shown below.

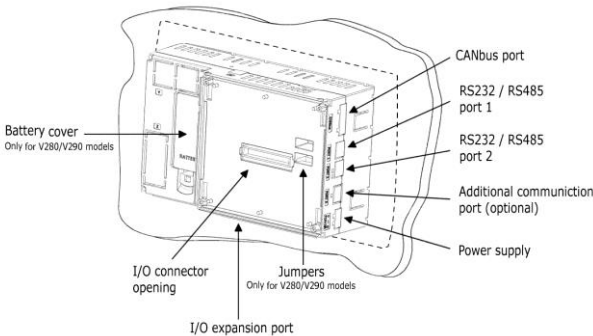

Wiring: General

- This equipment is designed to operate only in SELV/PELV/Class 2/Limited Power environments
- All power supplies in the system must include double insulation. Power supply outputs must be rated as SELV/PELV/Class 2/Limited Power.
- Do not connect either the 'Neutral or 'Line' signal of the 110/220VAC to device's 0V pin.
- Do not touch live wires.



- All wiring activities should be performed while power is OFF.
- Unused pins should not be connected. Ignoring this directive may damage the device



Caution

- To avoid damaging the wire, do not exceed a maximum torque of 0.5 N·m (5 kgf·cm)
- Do not use tin, solder, or any substance on stripped wire that might cause the wire strand to break

Use crimp terminals for wiring; use 26-14 AWG wire (0.13 mm²–2.08 mm²).

1. Strip the wire to a length of 7±0.5mm (0.250–0.300").
2. Unscrew the terminal to its widest position before inserting a wire.
3. Insert the wire completely into the terminal to ensure a proper connection.
4. Tighten enough to keep the wire from pulling free.

Wiring Guidelines

- Use separate wiring ducts for each of the following groups:
 - Group 1: Low voltage I/O and supply lines, communication lines.
 - Group 2: High voltage Lines, Low voltage noisy lines like motor driver outputs.

Separate these groups by at least 10cm (4"). If this is not possible, cross the ducts at a 90° angle.

- For proper system operation, all 0V points in the system should be connected to the system 0V supply rail.

Earthing the Controller

To maximize system performance, avoid electromagnetic interference as follows:

- Use a metal cabinet.
- Connect the 0V terminal to the earth ground of the system at one point, preferably as near to the controller as possible.

Power Supply

The controller requires an external 12 or 24VDC power supply. The permissible input voltage range is 10.2-28.8VDC, with less than 10% ripple.



- You must use an external circuit protection device
- Install an external circuit breaker. Guard against short-circuiting in external wiring
- Double-check all wiring before turning on the power supply
- In the event of voltage fluctuations or non-conformity to voltage power supply specifications, connect the device to a regulated power supply

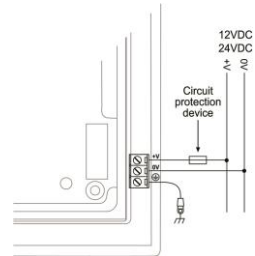

Communication Ports



- Turn off power before making communications connections
- Signals are related to the controller's 0V; this is the same 0V used by the power supply

Caution

- Always use the appropriate port adapters
- The serial ports are not isolated. If the controller is used with a non-isolated external device, avoid potential voltage that exceeds ± 10V

Serial Communications

This series comprises 2 RJ-11-type serial ports and a CANbus port.

COM1 is RS232 only. COM2 may be set to either RS232 or RS485 via jumper as described below. By default, the port is set to RS232.

Use RS232 to download programs from a PC, and to communicate with serial devices and applications, such as SCADA.

Use RS485 to create a multi-drop network containing up to 32 devices.

Caution ▪ COM1 & 2 are not isolated

Pinouts

To connect a PC to a port that is set to RS485, remove the RS485 connector, and connect the PC to the PLC via the programming cable. Note that this is possible only if flow control signals are not used (which is the standard case).

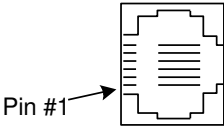
RS232		RS485**		Controller Port 
Pin #	Description	Pin #	Description	
1*	DTR signal	1	A signal (+)	
2	0V reference	2	(RS232 signal)	
3	TXD signal	3	(RS232 signal)	
4	RXD signal	4	(RS232 signal)	
5	0V reference	5	(RS232 signal)	
6*	DSR signal	6	B signal (-)	

*Standard programming cables do not provide connection points for pins 1 and 6.

** When a port is adapted to RS485, Pin 1 (DTR) is used for signal A, and Pin 6 (DSR) signal is used for signal B.

RS232 to RS485: Changing Jumper Settings

The port is set to RS232 by factory default.

To change the settings, first remove the Snap-in I/O Module, if one is installed, and then set the jumpers according to the following table.

Note:

For V230/V280/V290 modules only there is a small window as described on page 6 for jumper setting so there is no need to open the controller.



- Before you begin, touch a grounded object to discharge any electrostatic charge
- Before removing a Snap-in I/O Module or opening the controller, you must turn off the power

RS232/RS485 Jumper Settings

Jumper	1	2	3	4
RS232*	A	A	A	A
RS485	B	B	B	B
RS485 Termination	A	A	B	B

*Default factory setting.

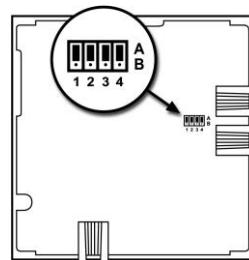

Removing a Snap-in I/O Module

1. Locate the four buttons on the sides of the module, two on either side.
2. Press the buttons and hold them down to open the locking mechanism.
3. Gently rock the module from side to side, easing the module from the controller.

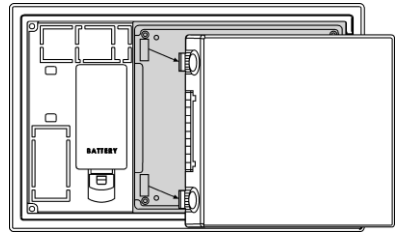
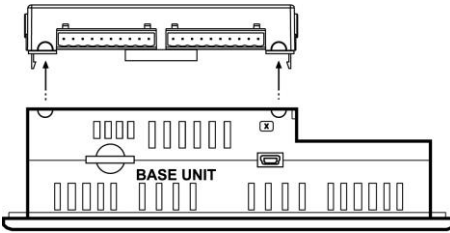

Re-installing a Snap-in I/O Module

1. Line the circular guidelines on the controller up with the guidelines on the Snap-in I/O Module as shown below.
2. Apply even pressure on all 4 corners until you hear a distinct 'click'. The module is now installed. Check that all sides and corners are correctly aligned.

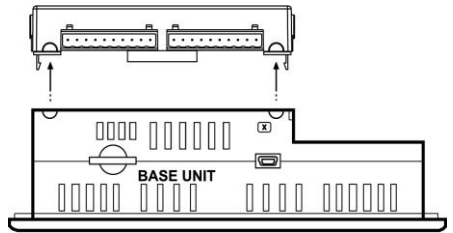
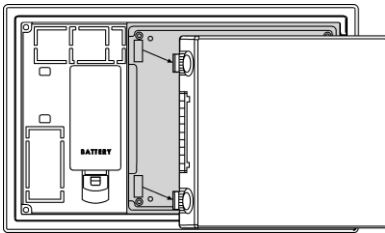

CANbus

These controllers comprise a CANbus port. Use this to create a decentralized control network using one of the following CAN protocols:

- CANopen: 127 controllers or external devices
- Unitronics' proprietary UniCAN: 60 controllers, (512 data bytes per scan)

The CANbus port is galvanically isolated.

CANbus Wiring

Use twisted-pair cable. DeviceNet® thick shielded twisted pair cable is recommended.

Network terminators: These are supplied with the controller. Place terminators at each end of the CANbus network.

Resistance must be set to 1%, 121Ω, 1/4W.

Connect ground signal to the earth at only one point, near the power supply.

The network power supply need not be at the end of the network.

CANbus Connector

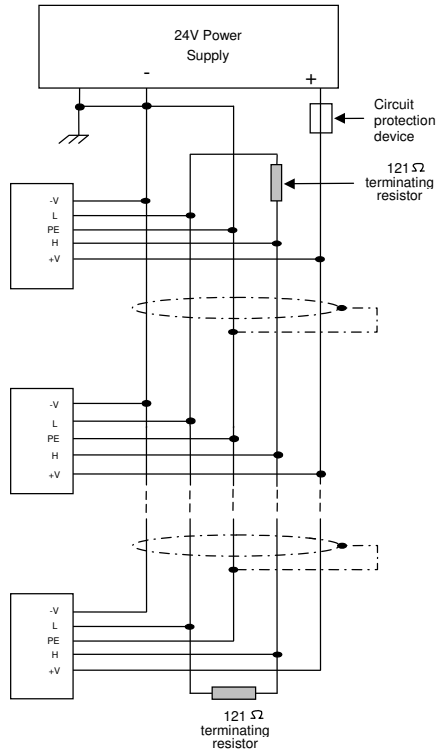
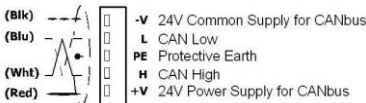

The information in this document reflects products at the date of printing. Unitronics reserves the right, subject to all applicable laws, at any time, at its sole discretion, and without notice, to discontinue or change the features, designs, materials and other specifications of its products, and to either permanently or temporarily withdraw any of the forgoing from the market.

All information in this document is provided "as is" without warranty of any kind, either expressed or implied, including but not limited to any implied warranties of merchantability, fitness for a particular purpose, or non-infringement. Unitronics assumes no responsibility for errors or omissions in the information presented in this document. In no event shall Unitronics be liable for any special, incidental, indirect or consequential damages of any kind, or any damages whatsoever arising out of or in connection with the use or performance of this information.

The tradenames, trademarks, logos and service marks presented in this document, including their design, are the property of Unitronics (1989) (R'G) Ltd. or other third parties and you are not permitted to use them without the prior written consent of Unitronics or such third party as may own them