

# IO-D16A3-RO16

## XL I/O Expansion Module Installation Guide

The Unitronics® IO-D16A3-RO16 is an XL I/O expansion module for use in conjunction with specific Unitronics controllers. XL modules comprise enhanced I/O configurations and detachable I/O connectors. A local or remote I/O adapter module is required to interface between the expansion module and the PLC controller and provide power to the expansion modules in the system.

The I/O expansion module provides:



- 16 digital inputs, including 2 HSC
- 3 analog inputs
- 16 relay outputs

For additional information and technical specifications, visit the Technical Library at [www.unitronics.com](http://www.unitronics.com).

### Component Identification

1	Module-to-module connector
2	Status indicator
3	Output connectors
4	Output power supply connection points
5	I/O address labels (provided with module)
6	Input/output status indicators
7	Module-to-module connector port
8	Input connectors

-  Failure to comply with appropriate safety guidelines can cause severe personal injury or damage to property.

-  Only qualified personnel should service and operate this device.
-  When power is turned on, do not connect or disconnect the device to avoid damaging the system.

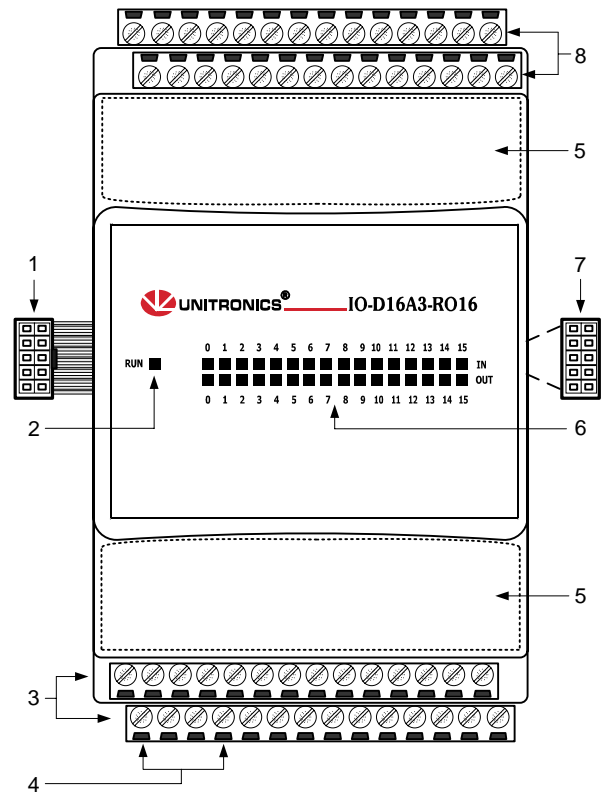

### Mounting the Module

To mount the module on a 35mm DIN-rail, snap it squarely onto the DIN-rail, as shown below.

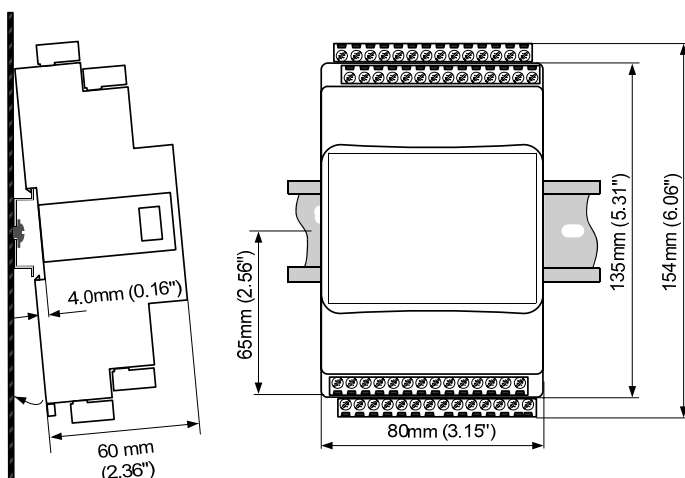

- Install the module in an upright position.
- To ensure good ventilation, leave at least 50mm between the device and all other objects above or below it.
- Install at a maximum distance from high-voltage cables and power equipment.

### Connecting Modules

To connect a module to the adapter or expansion module:

1. Push the module-to-module connector (1) into the port (2) located on the right side of the module or adapter.
2. Push the protective cap (3) into the connector port of the last module. The cap is supplied with the adapter.

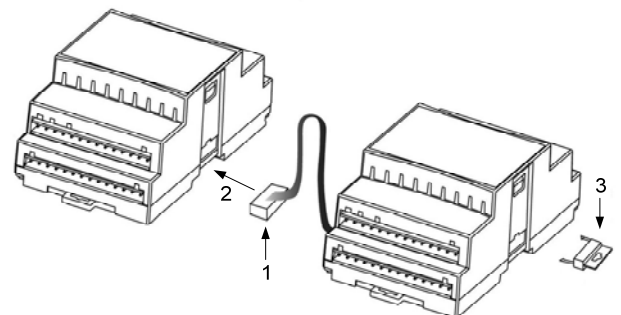

## Wiring Considerations

- Use crimp terminals for wiring and use 26-12 AWG wire (0.13mm<sup>2</sup>–3.31mm<sup>2</sup>).
- Strip the wire to a length of 7±0.5mm (0.250–0.300”).
- Do not route input cables together with output cables through the same multi-core cable or wire.
- Use wire that is correctly sized for the load. Allow for voltage drop and noise interference with extended input lines.

**Note:** Connect the adapter 0V and the I/O 0V to the same line.



- Install an external circuit breaker. Guard against short-circuiting in external wiring.
- Do not connect unused pins. Ignoring this directive may damage the device.
- To avoid damaging wires, do not exceed a maximum torque of 0.5 Nm (5 kgf-cm).
- Do not use tin, solder, or any substance on stripped wire that might cause the wire strand to break.

## Daisy Chaining

To facilitate wiring, you can wire the following pins in series (daisy chain). Use both pins provided for this purpose.

Input connector pin: n/p. Output connector pins: +V, 0V, C0, C1.

Ensure that the total current drain on any single line does not exceed 10A. If a specific pin requires more than 10A, connect it with a separate wire. The following diagram demonstrates the wiring options:

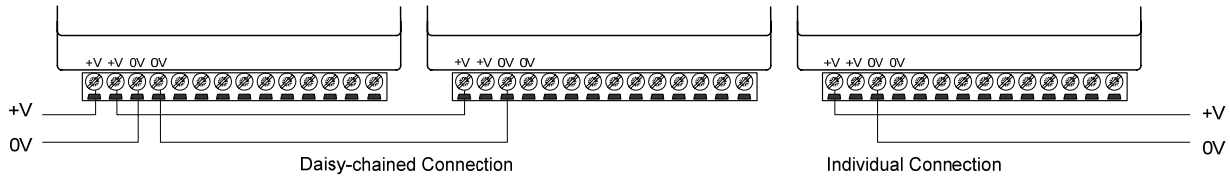

## Wiring Inputs

The following diagram shows the input connectors with pin numbers and corresponding LED numbers.

**Note:** Where input numbers are stated, the intention is the LED number.

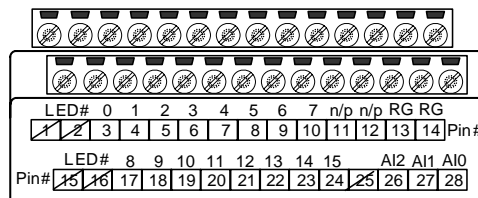

## Wiring Digital Inputs

- Inputs may be wired as either pnp (positive logic) or npn (negative logic).
- Inputs 4 and 6 can function as high-speed counters, frequency measurers, or general purpose digital inputs (set in software).
- Inputs 5 and 7 can function either as counter reset inputs or general purpose digital inputs (set in software).
- For information on connecting RG pins, refer to *Connecting RG Pins*.

### pnp (positive logic) inputs 0-7

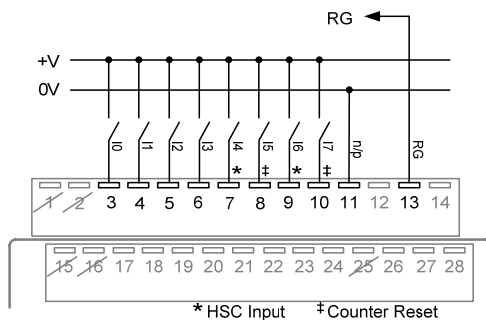

### pnp (positive logic) inputs 8-15

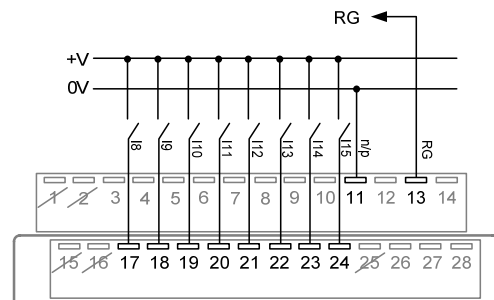

### npn (negative logic) inputs 0-7

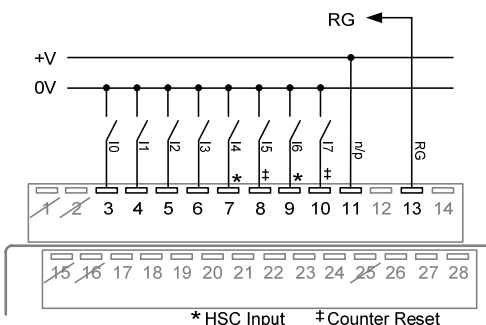

### npn (negative logic) inputs 8-15

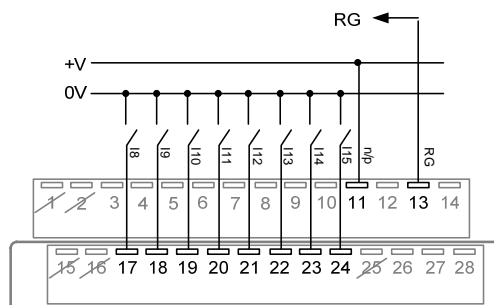



## Increasing Contact Life Span

To increase the life span of the relay contacts and protect against potential damage by reverse EMF, connect one of the following:

- A clamping diode in parallel with each inductive DC load.
- An RC snubber circuit in parallel with each inductive AC load.

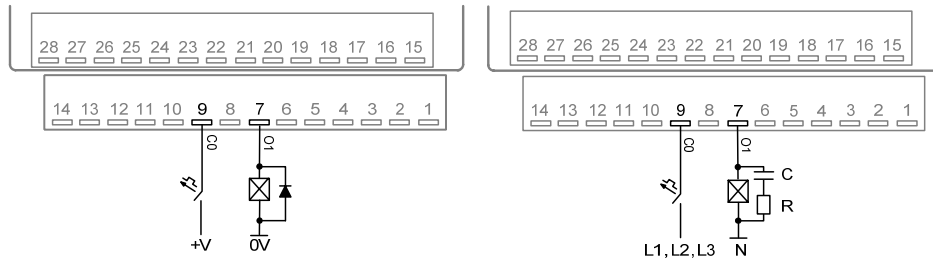

## Addressing Inputs and Outputs on Expansion Modules

The PLC software assigns a unique address to each input and output in the system. The address comprises a letter and a number. The letter indicates whether the I/O is an input (I) or output (O) and the number indicates its location (both the location of the expansion module in the system and the I/O position on the module).

The I/O addressing scheme depends on the adapter type and location. Adapters may be local or remote. Local adapters must be located close to the PLC. Remote adapters are connected to the PLC via CANbus. In addition, Unitronics offers I/O modules that contain a built-in adapter. Available adapter options may be found at [www.unitronics.com](http://www.unitronics.com).

The following example is based on a local EX-A1 adapter and may be used to calculate the number used by the PLC for inputs and outputs:

$$32 + 16x + y$$

Where: X is the number representing the module location (0-7) and Y is the number of the input or output on the module (0-15).

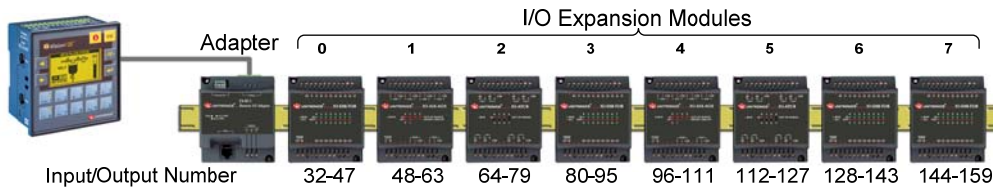

The module is supplied with a set of labels – select the label appropriate to the position of the module. For more information, refer to the *Configuring I/O Expansion Modules* topic in the on-line help of the software supplied with the controller.

The information in this document reflects products at the date of printing. Unitronics reserves the right, subject to all applicable laws, at any time, at its sole discretion, and without notice, to discontinue or change the features, designs, materials and other specifications of its products, and to either permanently or temporarily withdraw any of the foregoing from the market. All information in this document is provided "as is" without warranty of any kind, either expressed or implied, including but not limited to any implied warranties of merchantability, fitness for a particular purpose, or non-infringement. Unitronics assumes no responsibility for errors or omissions in the information presented in this document. In no event shall Unitronics be liable for any special, incidental, indirect or consequential damages of any kind, or any damages whatsoever arising out of or in connection with the use or performance of this information. The tradenames, trademarks, logos and service marks presented in this document, including their design, are the property of Unitronics (1989) (R'G) Ltd. or other third parties and you are not permitted to use them without the prior written consent of Unitronics or such third party as may own them.